

# = iSTORMY =

## EUROPEAN COMMISSION

HORIZON 2020 PROGRAMME – TOPIC: Hybridisation of battery systems for stationary energy storage

Interoperable, modular and Smart hybrid energy STORage system for stationarY applications

GRANT AGREEMENT No. 963527



## Deliverable Report

D2.1 – Medium-fidelity models of different cells technology and performance characterization

<b>Deliverable No.</b>	iSTORMY D2.1	
<b>Related WP</b>	WP2	
<b>Deliverable Title</b>	Medium-fidelity models of different cells technology and performance characterization	
<b>Deliverable Date</b>	30-09-2021	
<b>Deliverable Type</b>	OTHER	
<b>Dissemination level</b>	Public (PU)	
<b>Written By</b>	Boris Berseneff (CEA)	10-09-2021
<b>Checked by</b>	Erik Hoedemaekers (TNO)	29-09-2021
<b>Reviewed by</b>	Eneko Unamuno (MGEP)	29-09-2021
<b>Approved by</b>	Thomas Geury (VUB)	30-09-2021
<b>Status</b>	Final	30-09-2021
<b>CEA deliverable number</b>	DEHT/LV/2021-114	

### *Disclaimer/ Acknowledgment*



Copyright ©, all rights reserved. This document or any part thereof may not be made public or disclosed, copied or otherwise reproduced or used in any form or by any means, without prior permission in writing from the iSTORMY Consortium. Neither the iSTORMY Consortium nor any of its members, their officers, employees or agents shall be liable or responsible, in negligence or otherwise, for any loss, damage or expense whatever sustained by any person as a result of the use, in any manner or form, of any knowledge, information or data contained in this document, or due to any inaccuracy, omission or error therein contained.

All Intellectual Property Rights, know-how and information provided by and/or arising from this document, such as designs, documentation, as well as preparatory material in that regard, is and shall remain the exclusive property of the iSTORMY Consortium and any of its members or its licensors. Nothing contained in this document shall give, or shall be construed as giving, any right, title, ownership, interest, license or any other right in or to any IP, know-how and information.

This project has received funding from the European Union's Horizon 2020 research and innovation programme under grant agreement No 963527. The information and views set out in this publication does not necessarily reflect the official opinion of the European Commission. Neither the European Union institutions and bodies nor any person acting on their behalf, may be held responsible for the use which may be made of the information contained therein.

## Publishable summary

The iSTORMY project aims at developing an interoperable and modular Hybrid Energy Storage System (HESS) by demonstrating various use cases and seamlessly interface the grid to provide multiple services. In order to fulfil the project objectives and, among others, in order to minimize the TCO of the total storage system, one must carry out optimizations and simulations of the HESS. These studies require the modelling, with a medium-fidelity model, of the four commercial cell battery references that have been selected, including one second life reference, for the project. The type of model selected is an Electric Equivalent Circuit (EEC) model. It gives cell voltage as a function of cell State of Charge (SoC), cell temperature and cell charge and discharge current. It is implemented in Matlab/Simulink and coupled with a thermal model. Model parameters and Open Circuit Voltage (OCV) are identified using data obtained from a test campaign performed by TNO and CEG. Several SoC, temperatures and charge and discharge currents conditions have been defined so that the mapped values of the parameters encompass all future simulations and optimization conditions. Results show that most of the voltage errors (voltage is the main output of the model) are below 2% in the expected operating region. Therefore, the objective of having a medium-fidelity model is fulfilled. Except stated differently, CEA is responsible for the work herein.

## Contents

1	Introduction: context and objectives. ....	6
2	Methods.....	6
2.1	Battery modelling.....	6
2.1.1	Electric equivalent circuit model .....	6
2.1.2	Thermal model.....	7
2.1.3	Battery pack model.....	7
2.2	Cell tests.....	10
2.2.1	Main cell characteristics .....	10
2.2.2	Cell test protocol.....	10
2.3	Model parameter identification.....	12
2.3.1	OCV identification.....	12
2.3.2	Thermal model parameter identification .....	12
2.3.3	Electrical model parameter identification .....	12
3	Results and discussion .....	13
3.1	Parameter identification results .....	13
3.1.1	NMC 1st life cell .....	13
3.1.2	LTO 1 <sup>st</sup> life cell.....	17
3.1.3	LFP 1 <sup>st</sup> life cell.....	20
3.1.4	LFP 2 <sup>nd</sup> life cell.....	24
3.2	Discussion and conclusion .....	27
4	Risk Register.....	28
5	References .....	29
	Acknowledgement.....	30
	Appendix A – Use cases configuration.....	31

## Table of Figures

Figure 1: Equivalent circuits model .....	7
Figure 2: Battery module model implemented in Matlab/Simulink R2020b: top-level implementation. ....	8
Figure 3: EEC of a 2S3P battery pack. Rint is the internal series interconnection resistor. Rco is the pack interconnection series resistor. ....	9
Figure 4: OCV identification for NMC 1st life cell. ....	14
Figure 5: NMC 1st life cell model parameters identification error. Voltage error vs temperature, SoC and current. ....	14
Figure 6: NMC 1st life cell model parameters identification error. Voltage error vs temperature and SoC for all C-Rate. ....	15
Figure 7: Sum of all internal resistance of NMC 1st life cell model at 0°C. Red markers show where values have been saturated. ....	15
Figure 8: Sum of all internal resistance of NMC 1st life cell model at 25°C. ....	16
Figure 9: Sum of all internal resistance of NMC 1st life cell model at 45°C. ....	16
Figure 10: OCV identification for LTO 1st life cell. ....	17
Figure 11: LTO 1st life cell model parameters identification error. Voltage error vs temperature, SoC and current. ....	18
Figure 12: LTO 1st life cell model parameters identification error. Voltage error vs temperature and SoC for all C-Rate. ....	18
Figure 13: Sum of all internal resistance of LTO 1st life cell model at 0°C. Red markers show where values have been saturated. ....	19
Figure 14: Sum of all internal resistance of LTO 1st life cell model at 25°C. ....	19
Figure 15: Sum of all internal resistance of LTO 1st life cell model at 45°C. ....	20
Figure 16: OCV identification for LFP 1 <sup>st</sup> life cell. ....	21
Figure 17: LFP 1 <sup>st</sup> life cell model parameters identification error. Voltage error vs temperature, SoC and current. ....	21
Figure 18: LFP 1 <sup>st</sup> life cell model parameters identification error. Voltage error vs temperature and SoC for all C-Rate. ....	22
Figure 19: Sum of all internal resistance of LFP 1 <sup>st</sup> life cell model at 0°C. Red markers show where values have been saturated. ....	22
Figure 20: Sum of all internal resistance of LFP 1 <sup>st</sup> life cell model at 25°C. Red markers show where values have been saturated. ....	23
Figure 21: Sum of all internal resistance of LFP 1 <sup>st</sup> life cell model at 45°C. Red markers show where values have been saturated. ....	23
Figure 22: OCV identification for LFP 2 <sup>nd</sup> life cells. ....	24
Figure 23: LFP 2 <sup>nd</sup> life cell model parameters identification error. Voltage error vs temperature, SoC and current. ....	25
Figure 24: LFP 2 <sup>nd</sup> life cell model parameters identification error. Voltage error vs temperature and SoC for all C-Rate. ....	25
Figure 25: Sum of all internal resistance of 2 <sup>nd</sup> life cell model at 0°C. Red markers show where values have been saturated. ....	26
Figure 26: Sum of all internal resistance of LFP 2 <sup>nd</sup> life cell model at 25°C. Red markers show where values have been saturated. ....	26
Figure 27: Sum of all internal resistance of LFP 2 <sup>nd</sup> life cell model at 45°C. Red markers show where values have been saturated. ....	27

## Tables

Table 1: Main characteristics of the selected cells. ....	10
Table 2: Initialization protocol. ....	11
Table 3: CC charge/discharge tests protocol. ....	11
Table 4: HPPC tests protocol. ....	12

## 1 Introduction: context and objectives.

The iSTORMY project aims at developing an interoperable and modular Hybrid Energy Storage System (HESS), by demonstrating various use cases and seamlessly interface the grid to provide multiple services, such as a combination of load levelling, frequency regulation, provision of backup power, at minimum cost. The HESS consists of batteries (1st and 2nd life), power electronics and thermal management and control systems [1].

In order to fulfil the project objectives and, among others, in order to minimize the TCO of the total storage system, one must carry out optimizations and simulations of the HESS. These studies require the modelling of the four selected lithium-ion battery cells. The work described herein is part of the WP2 *Optimized Hybrid Battery Modules and Stacks Concepts with Advanced Battery Management Systems*. More specifically, we aim at developing medium-fidelity electrothermal models. As medium-fidelity is not defined in the grant agreement, we consider an accuracy objective of 5% or better.

In this deliverable, first we describe the cell model used for HESS simulation. Then, we show the tests campaign carried out for parametrizing the model. Finally, we discuss the model parameters fitting and the model accuracy.

Except when stated differently, CEA is responsible for the work herein.

## 2 Methods

### 2.1 Battery modelling

The electric behaviour of lithium-ion battery cells is modelled with an electrothermal model. This model couples two models: an electric equivalent circuit model and a thermal model.

#### 2.1.1 Electric equivalent circuit model

The constant RC equivalent circuit model is derived from the classical Electric Equivalent Circuit (EEC) model of lithium-ion battery cells [2]–[5].

This model is made of a DC voltage source, which models the variation of OCV (Open Circuit Voltage) as a function of SoC (State of Charge), in series with a variable resistor  $R_0$ , which models the internal resistance of the cell. In order to better model the dynamic voltage behaviour of the cell, extra RC parallel blocks are added in series (see figure 1). A  $\tau_i = R_i C_i$  value is defined for each RC block, depending on the dynamics of the current profiles applied to the model during the simulation of the HESS. Each RC parallel block represent a different timescale response under current variation. Hence, the number of blocks is defined manually as well as the  $\tau_i = R_i C_i$  values. Then, during the model parameters identification process, only  $R_i$  values are fitted by the algorithm. It allows a faster identification process ( $C_i$  values are calculated from the equation  $\tau_i = R_i C_i$ ).

The model parameter dependencies are:

- OCV depends on SoC and temperature but for medium-fidelity model, temperature dependency is considered negligible over SoC dependency [6];
- $R_0$ ,  $R_n$  and  $C_n$  parameters depend on cell SoC, cell temperature, cell C-rate (charge and discharge current) and cell SoH (State of Health).

The model parameters are identified by testing cells with current pulses under several SoC, temperature and current conditions (according to final use of the model, see Appendix A – Use cases configuration) and fitting the model behaviour to the test data.

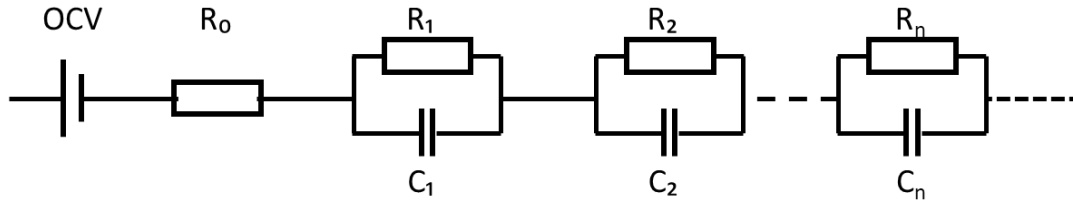

Figure 1: Equivalent circuits model

The model is implemented in Matlab/Simulink software R2020b and developed in the environment of MUSES platform (CEA multi-scale and multi-physics modelling platform).

### 2.1.2 Thermal model

A simple cell electrical model is used in order to estimate the cell temperature variation. The model is implemented in Matlab/Simulink software. It is made of three equations:

- Joule losses: heat generation inside the cell:

$$Q_{in}(t) = \sum_{i=0}^{i=n} R_i I_{cell}^2(t)$$

- Thermal exchange between the cell and its surrounding environment:

$$Q_{out}(t) = h \cdot S \frac{dT(t)}{dt}$$

- Thermal energy transfer through the cell:

$$T = \int \frac{Q_{in}(t) - Q_{out}(t)}{mC_p} dt$$

Where:

- $Q_{...}(t)$  [W] is the thermal power;
- $T$  [K] is the cell temperature, assumed homogeneous inside the cell;
- $m$  [kg] is the mass of the cell;
- $C_p$  [J.K<sup>-1</sup>.Kg<sup>-1</sup>] is the specific heat capacity of the cell;
- $S$  [m<sup>2</sup>] is the exchange surface of the cell;
- $h$  [W.m<sup>-2</sup>.K<sup>-1</sup>] is the heat transfer coefficient of the cell.

$m$ ,  $C_p$  and  $S$  parameters values are measured experimentally (see section 2.2.2.4).

$h$  parameter value depends on the cooling and thermal architecture of the battery pack. Typical values are 10 to 100 for air (stationary or forced convection) and 1000 to 10000 for water (stationary or forced convection).

### 2.1.3 Battery pack model

A battery pack is a series/parallel assembly of modules. A battery module is a series/parallel assembly of cells.

The cells are electrically interconnected and their connections are modelled with a resistor in series. Using the previously shown electrothermal cell model, the implemented Matlab/Simulink battery module model allows simulating each cell individually or, if we consider the battery module to be homogeneous, simulating only one cell and get the module results by applying Kirchhoff's circuit laws. The HESS model is then a series/parallel assembly of modules models.

Figure 2 shows the Matlab/Simulink top-level implementation of the model (inputs and outputs). Figure 3 shows, for illustration purposes, an EEC model of a 2S3P battery module.

The model inputs are power or current profiles and an ambient temperature profile. Its outputs are module and cell voltages, module and cell power(s), module current, SoC, SoH<sup>1</sup>, cell temperatures and cell Joule losses.

Work showed herein does not include the development of a module or pack thermal model. Therefore, the evolution of the  $h$  parameter value of each cell is unknown as well as its initial value. CEA recommends running sensibility analysis for diverse cooling technologies to study the impact of temperature management on cell performances and aging.

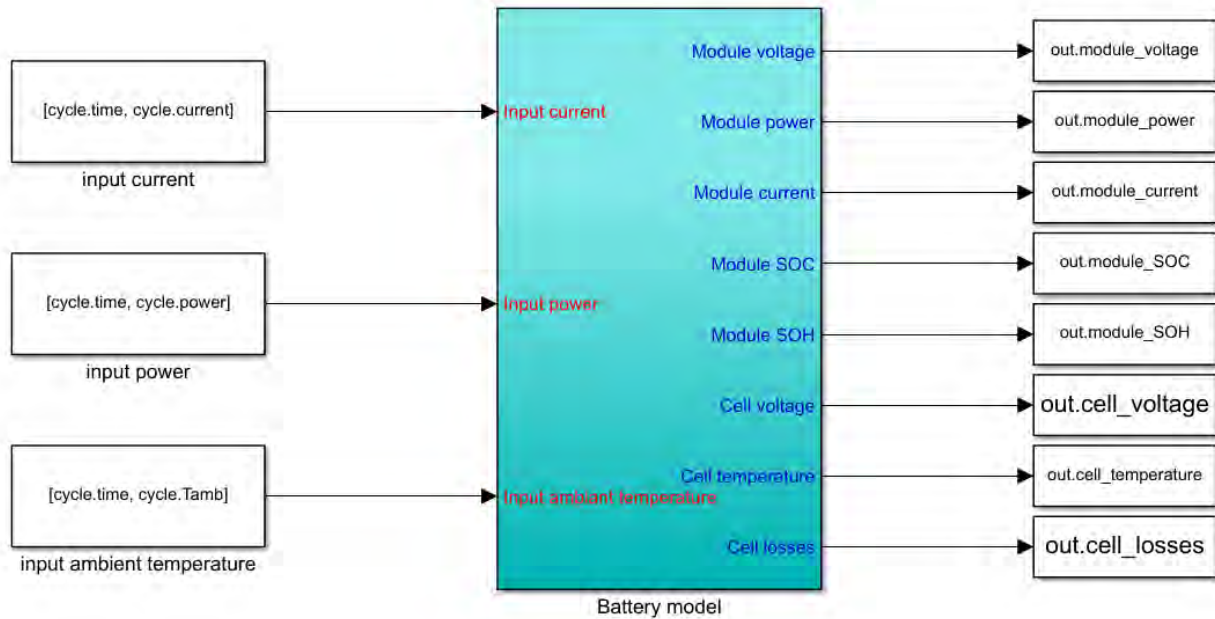

Figure 2: Battery module model implemented in Matlab/Simulink R2020b: top-level implementation.

<sup>1</sup> At this stage, cell aging model is not parametrized. Therefore, SoH value shall not be taken into account.



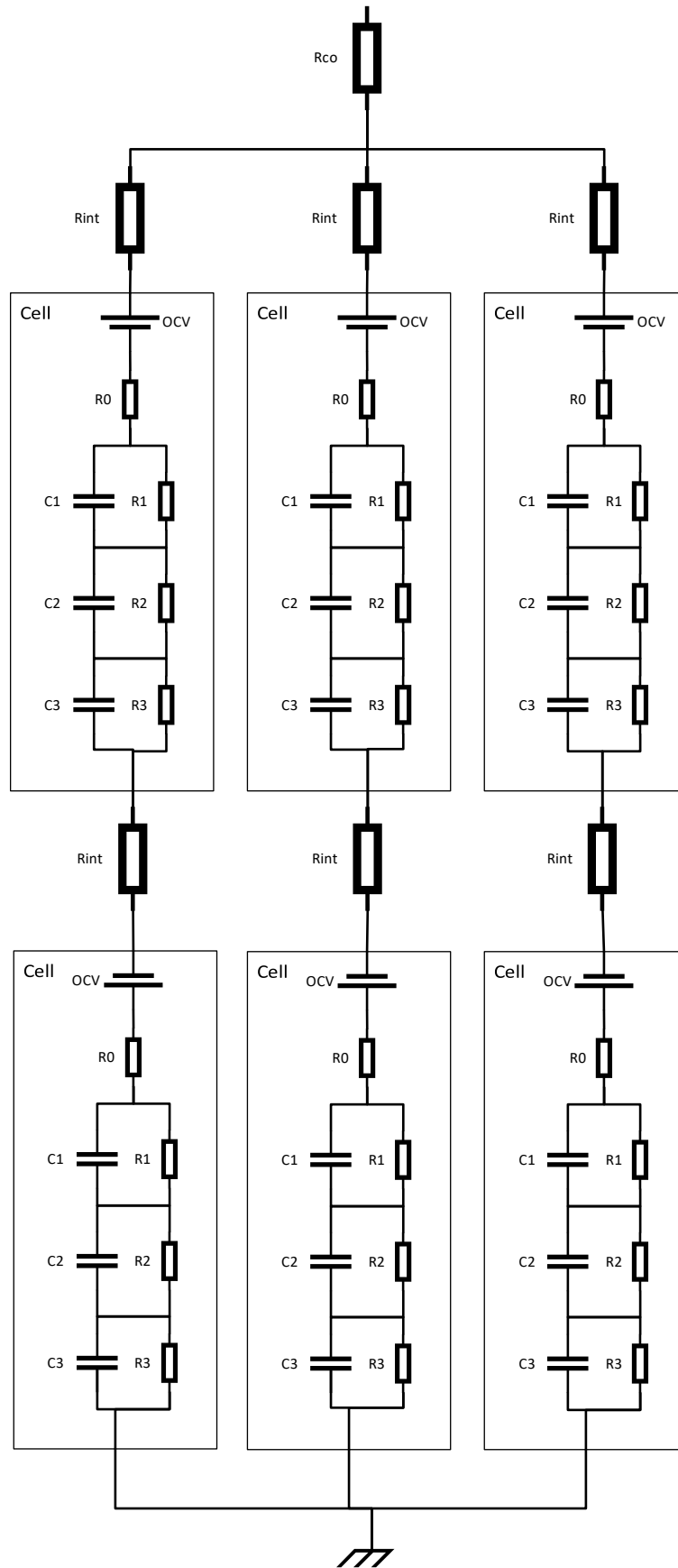

Figure 3: EEC of a 2S3P battery pack. Rint is the internal series interconnection resistor. Rco is the pack interconnection series resistor.

## 2.2 Cell tests

In order to parametrize the models of the four cells, TNO and CEG have carried out tests campaigns. Their purpose is to encompass all conditions the battery will meet during its operation (C-rate, temperature, SoC, see Appendix A – Use cases configuration) so that the model parameters can be identified accurately enough.

### 2.2.1 Main cell characteristics

Main characteristics of the four cells investigated in the project are given in table 1 .

Short name	NMC 1 <sup>st</sup> life	LTO 1 <sup>st</sup> life	LFP 1 <sup>st</sup> life	LFP 2 <sup>nd</sup> life
Manufacturer	Lishen	Toshiba	Unknown	A123
Commercial reference name	LP2714897-51	SCiB 23 Ah	Unknown	AMP20M1HD-A
Nominal capacity [Ah]	51	23	280	19.6
Nominal voltage [V]	3.56	2.3	3.2	3.3
Max/min voltage [V]	4.2 – 2.5	2.7 – 1.5	3.65 – 2.5	3.8 – 1.6
Format	Prismatic	Prismatic	Prismatic	Pouch
Mass [g]	925	550	5220	496
Max discharge current [A]	153 255 (30 s)	100 200 (10 s)	280	Approx. 360 (1200 W <sup>2</sup> )
Tested by	TNO	TNO	CEGASA	TNO

Table 1: Main characteristics of the selected cells.

### 2.2.2 Cell test protocol

The test protocol comprised of four parts.

- Initialization;
- Constant Current (CC) charge/discharge tests;
- Hybrid Pulse Power Characterization (HPPC) tests;
- Thermal capacity test.

The data monitored is:

- Voltage;
- Current;
- Temperature;
- Time.

The data is acquired at a 10 Hz sampling frequency (except for initialization protocol where the sampling frequency is variable).

<sup>2</sup> The A123 AMP20M1HD-A cell datasheet gives only the maximum discharge power.

### 2.2.2.1 Initialization protocol

Step	Action	Mode	Conditions	Comments
1	Set Temperature		25°C	
2	Rest		3h	
3	Charge	CC-CV	C/2, V <sub>max</sub> @0.05C	Full charge
4	Set Temperature		[25°C, 45°C, 0°C]	
5	Rest		3h	

Table 2: Initialization protocol.

### 2.2.2.2 CC charge/discharge tests (including OCV)

The experimental ranges during testing are:

- Temperature [25°C, 45°C, 0°C];
- C-rates [0.5, 1, 2].

Step	Action	Mode	Conditions	Comments
1-5	Initialization			See the initialization protocol
6	Set C-rate		C <sub>x</sub> = [0.1, 0.5, 1, 2]	
7	Discharge	CC	C <sub>x</sub> , V <sub>min</sub>	Full discharge
8	Rest		0.5h	
9	Charge	CC	C <sub>x</sub> , V <sub>max</sub>	Full charge
10	Rest		0.5h	
11	Discharge	CC	C/2, 12 min	10% SoC partial discharge
12	Go to		Go to step 1	Return to step 1 until all temperature and C-rate combinations have been completed

Table 3: CC charge/discharge tests protocol.

### 2.2.2.3 HPPC tests (including OCV)

The experimental ranges during testing are:

- Temperatures [25°C, 45°C, 0°C];
- C-rates [0.5, 1, 2];
- Discharge SoC points: [100%, 90%, 80%... 20%, 10%];
- Charge SoC points: [0%, 10%, 20%... 80%, 90%] (SoCstep = 10%).

Step	Action	Mode	Conditions	Comments
1-5	Initialization			See the initialization protocol
6	Set C-rate	CC	$C_x = [0.5, 1, 2]$	
7	Set pulse duration	CC	$t = (3600 \times \text{SoCstep}) / (C_x \times 100)$	
8	Discharge	CC	$C_x$ and $t$	Current pulse, discharging 10% SoC
9	Rest		1h at [25°C, 45°C], 3h at 0°C	
10	Go to		If SoC > 0% go to step 8 else continue to step 11	
11	Charge	CC	$C_x$ and $t$	Current pulse, charging 10% SoC
12	Rest		1h at [25°C, 45°C], 3h at 0°C	
13	Go to		If SoC < 90% go to step 11 else continue to step 14	Until all SoC, temperature and C-rate combinations have been completed
14	Discharge	CC	$C/2$ , 12 min	10% SoC partial discharge
15	Go to		Go to step 1	Return to step 1 until all SoC, temperature and C-rate combinations have been completed

Table 4: HPPC tests protocol.

### 2.2.2.4 Thermal capacity tests

During the thermal capacity tests, specific heat capacity and battery cell weight were measured. By measuring both parameters the heat capacity of the battery cell was calculated.

The specific heat capacity was measured by applying a heating foil to the battery cell, applying a known amount of electrical power to the heating foil and measuring the surface temperature of the cell. The battery cell and heating foil were thermally insulated from their direct environment by foam to minimize the heating energy losses of the heating foil to the surrounding environment.

## 2.3 Model parameter identification

### 2.3.1 OCV identification

The OCV identification is a three-step process. First, using only HPPC tests, we gather voltage values obtained after 1 hour rest during the test protocol at several SoC values. Then, we fit a polynomial function so that  $OCV = f(\text{SoC})$ . Finally, a mapping of OCV values is generated for several SoC values (typically, from 0 % to 100%, with a 5% step).

### 2.3.2 Thermal model parameter identification

Thermal model parameters identification is done by directly using thermal test data:  $m, C_p, S$ .

The specific heat capacity was determined by the relation between the applied heating power and the increase in battery cell surface temperature. By combining the specific heat capacity and the battery cell mass, the heat capacity of the battery cell was calculated.

The  $h$  parameter value needs to be manually estimated, depending on cooling and the thermal architecture of the HESS (see section 2.1.3).

### 2.3.3 Electrical model parameter identification

The Cell model parameters are identified using an undisclosed CEA algorithm based on inversion of a linearized problem. Its inputs are cell tests (CC and HPPC), i.e.:

- OCV mapping;

- Cell voltages;
- Cell currents;
- Cell SoCs;
- Cell temperatures.

The output, for each model parameter, is set of mapped values where:

- OCV depends on SoC (temperature dependency is considered negligible);
- $R_0$ ,  $R_n$  and  $C_n$  parameters depend on cell SoC, cell temperature and cell C-rate.

The mapped points coincide with the SoC, cell temperatures and cell c-rates used in the experiment described in section 2.2.2.

Considering the dynamics of the power profiles of the selected use cases (frequency support, EV charging support, frequency support and long-term balancing, see Appendix A – Use cases configuration), the  $\tau_i = R_i C_i$  values chosen are:

- $\tau_1 = 1$  s
- $\tau_2 = 10$  s
- $\tau_3 = 100$  s

Due to several reasons (SoC calculation error, calibration error between the computed OCV and the HPPC current pulses, non-optimal breakpoints selection for identification...), the identification process might give aberrant outputs with very high values of resistor. In such case, values are saturated to  $5e-2 \Omega$ . These points are emphasized in the resistors map charts with red markers. Furthermore, results shown herein could be improved.

## 3 Results and discussion

### 3.1 Parameter identification results

The figures below show the parameters identification results for each cell.

First, we show the OCV identification for each cell. OCV is plotted as a function of SoC. The blue crosses are the experimental data, that is, for each SoC step, the last voltage value measured during the rest phases (see section 2.2.2.3). The red circles show the polynomial fit. The cell model linearly interpolates these fitted data in order to compute the OCV.

Then we show the cell model parameters identification error. The voltage error is plotted as a function of experimental voltage, SoC, temperature and current. The voltage error measures the inaccuracy of the identification algorithm. Each point is the difference between the experimental voltage and the calculated voltage with the identification algorithm, for every HPPC experimental points (except rest phases). This voltage error is therefore a good indication of the model accuracy when used for simulations.

Finally, we plot the sum of all internal resistances as a function of SoC and C-Rate for several temperature.

#### 3.1.1 NMC 1st life cell

Results show that for NMC 1st life cell uncertainty is higher at low SoC. Although identification performs well regardless of temperature and current values, voltage error is higher at low SoC (figure 5 and figure 6). Internal resistor maps show higher values at low SoC and high C-Rate for 25°C and 0°C which is consistent with a higher uncertainty at these conditions (figure 7, figure 8 and figure 9).

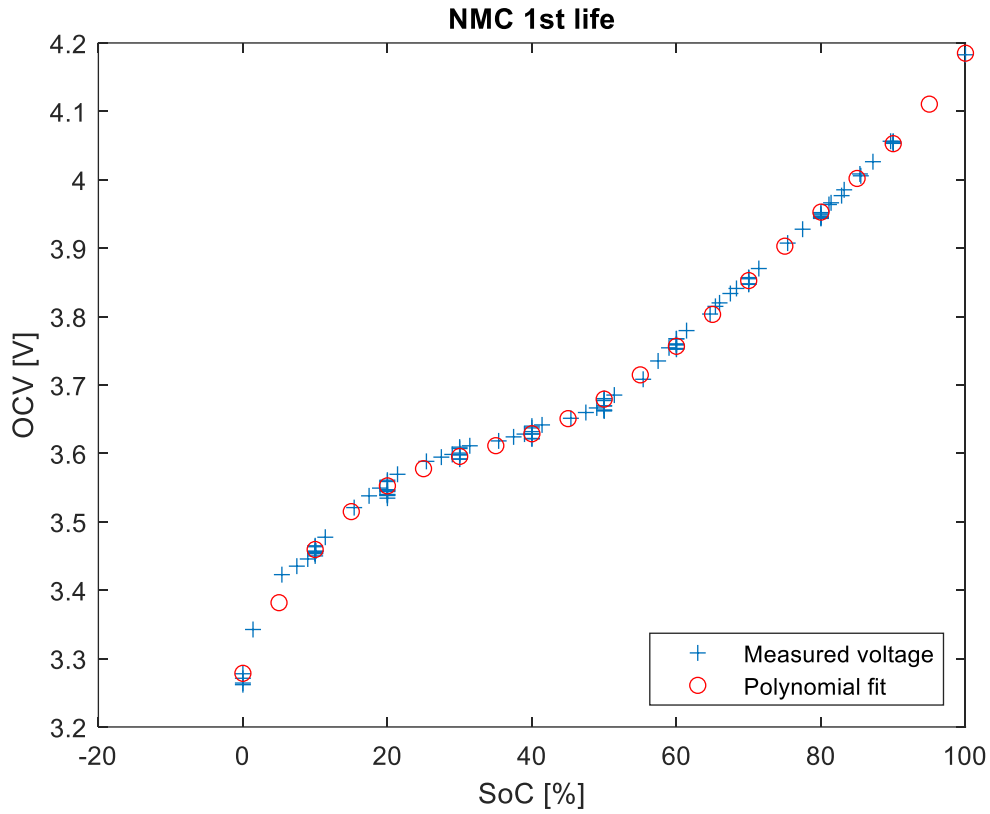

Figure 4: OCV identification for NMC 1st life cell.

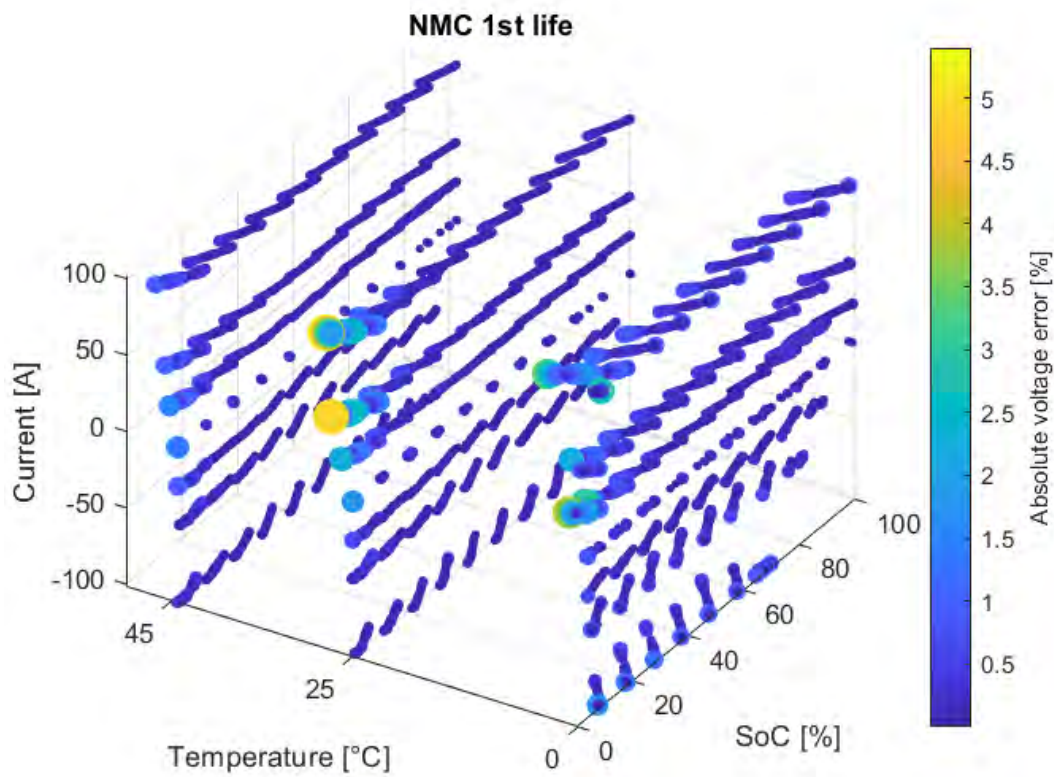

Figure 5: NMC 1st life cell model parameters identification error. Voltage error vs temperature, SoC and current.

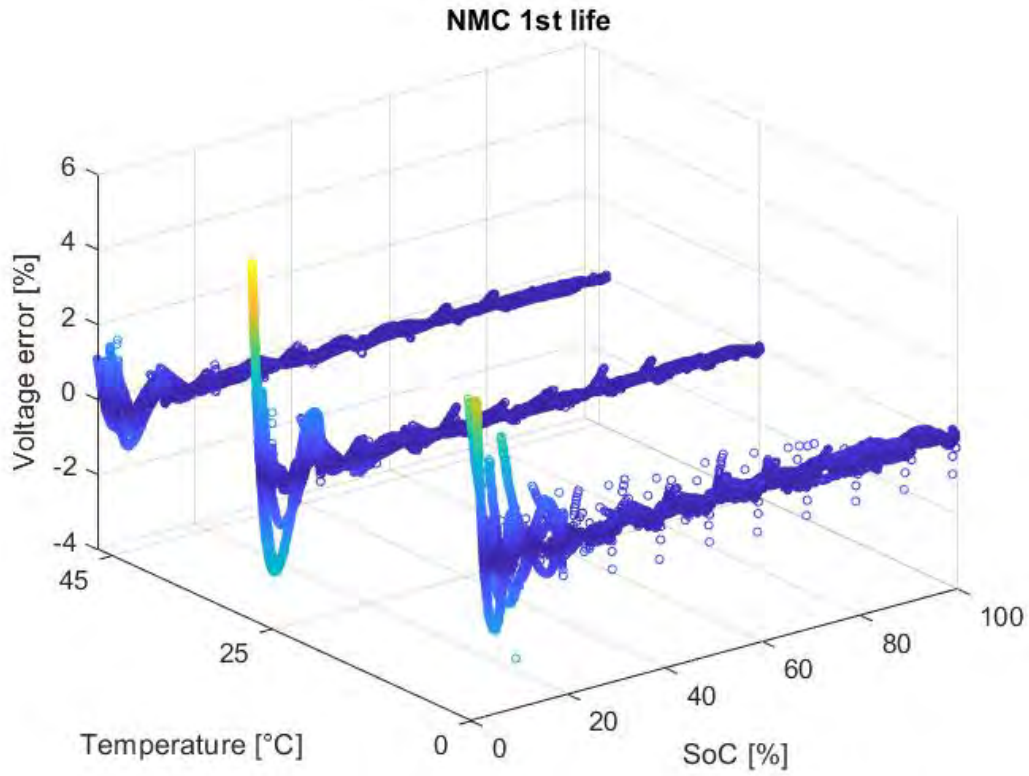

Figure 6: NMC 1st life cell model parameters identification error. Voltage error vs temperature and SoC for all C-Rate.

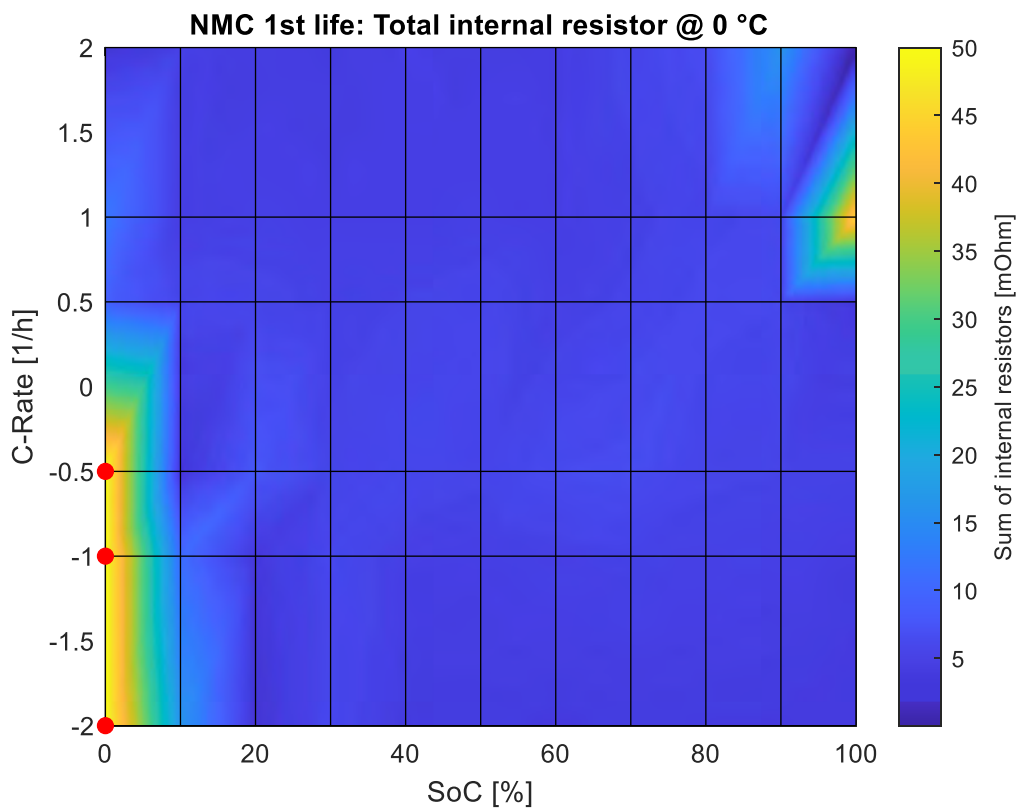

Figure 7: Sum of all internal resistance of NMC 1st life cell model at 0°C. Red markers show where values have been saturated.

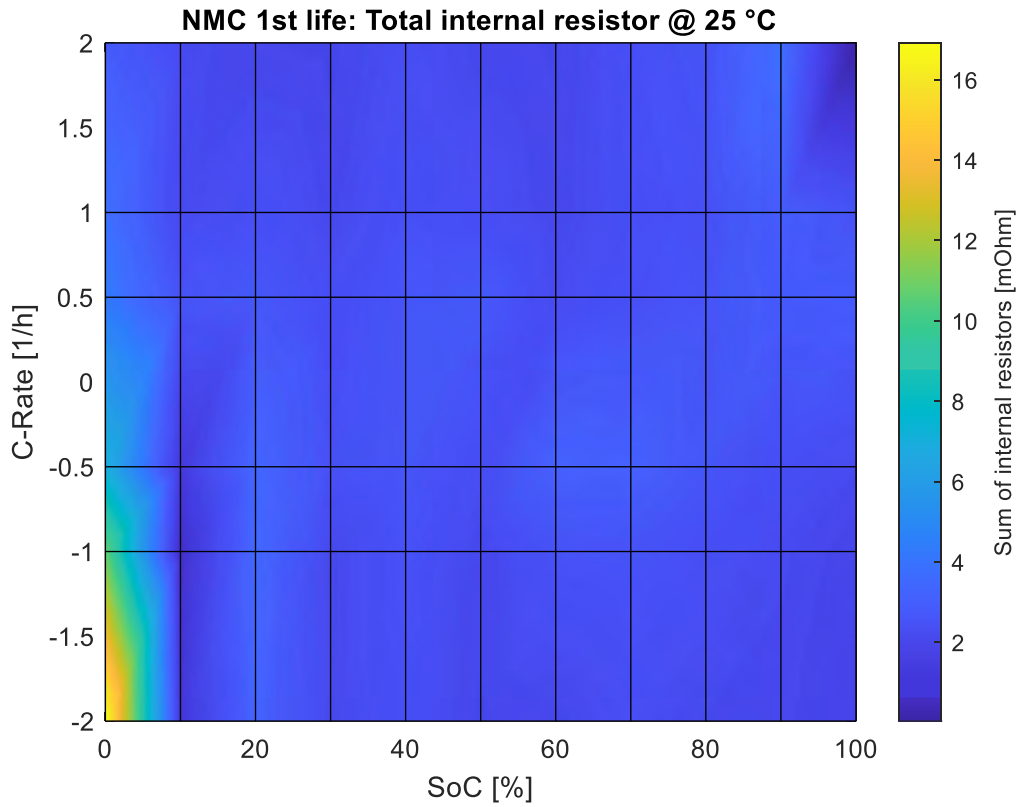

Figure 8: Sum of all internal resistance of NMC 1st life cell model at 25°C.

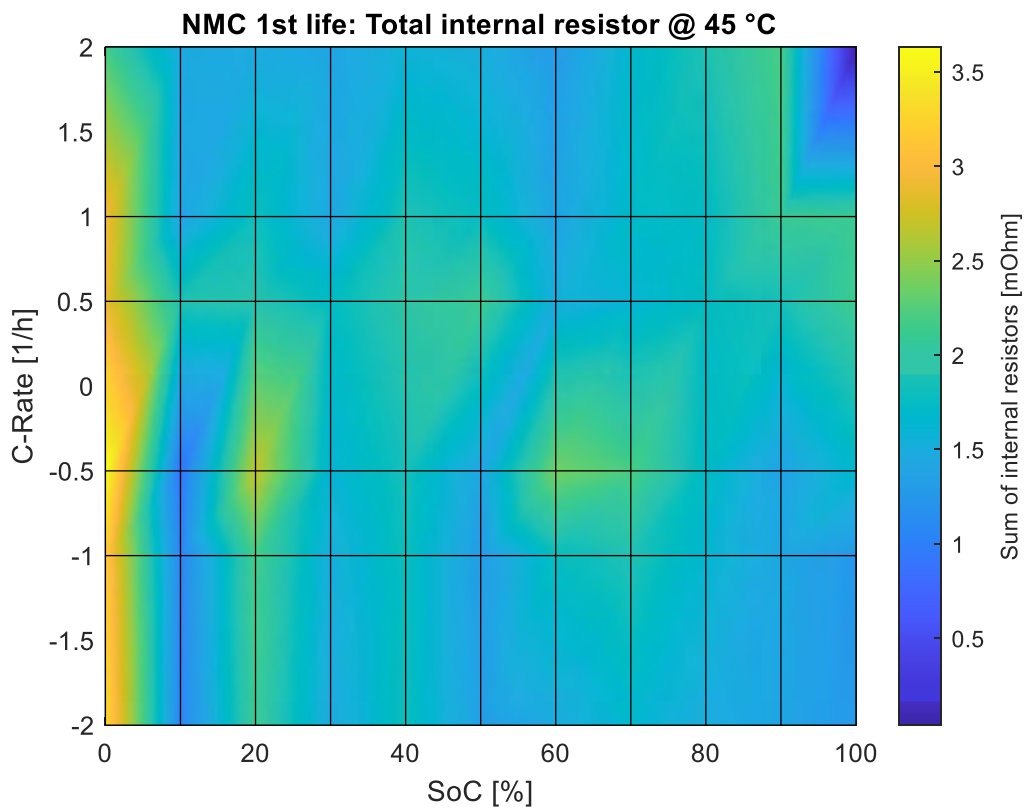

Figure 9: Sum of all internal resistance of NMC 1st life cell model at 45°C.



### 3.1.2 LTO 1<sup>st</sup> life cell

Same observations as for NMC 1<sup>st</sup> life cell can be made for LTO 1<sup>st</sup> life cell. Uncertainty is higher at low SoC regardless, or nearly so, temperature and current values (figure 11 and figure 12). Internal resistor maps show higher values at low SoC and high C-Rate for 25°C and 0°C, which is consistent with higher uncertainty at these conditions (figure 13, figure 14 and figure 15). Higher values appear also at 0°C and high SoC, which means that the identification algorithm has more difficulties to fit the experimental data in this area.

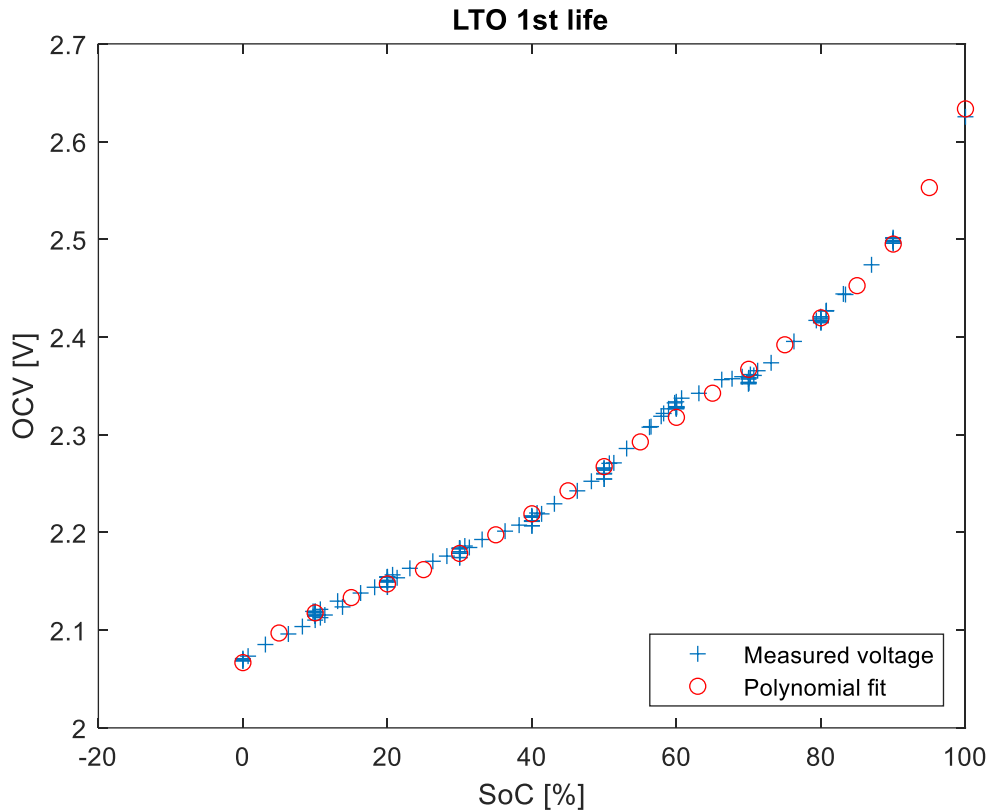

Figure 10: OCV identification for LTO 1st life cell.

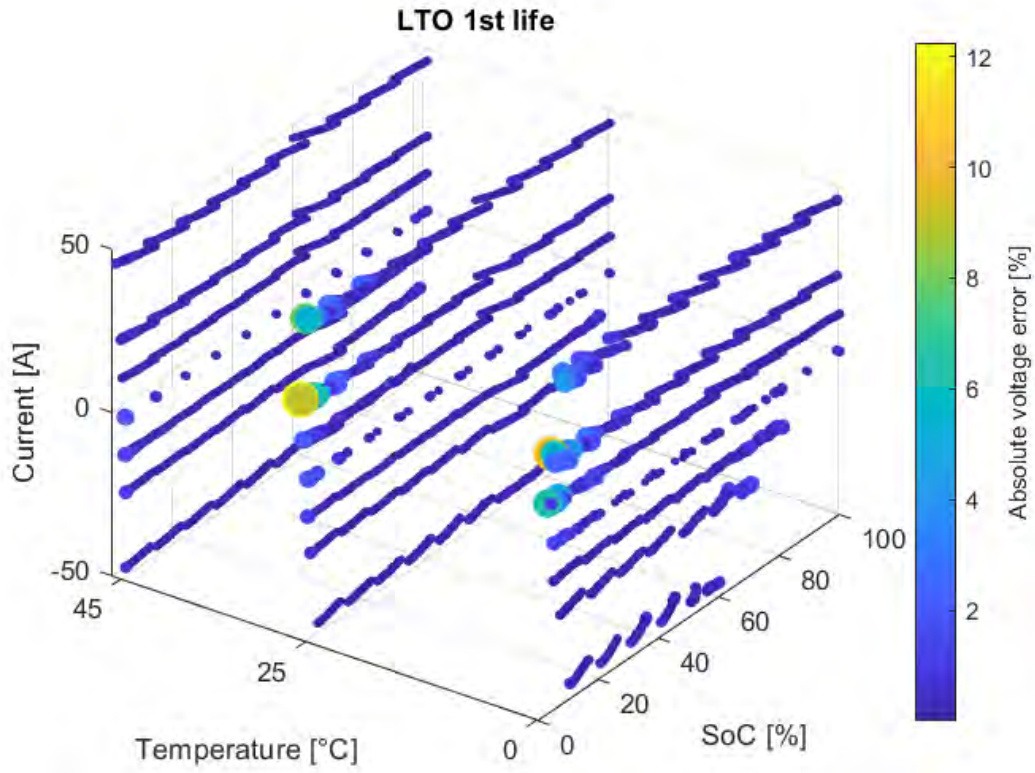

Figure 11: LTO 1st life cell model parameters identification error. Voltage error vs temperature, SoC and current.

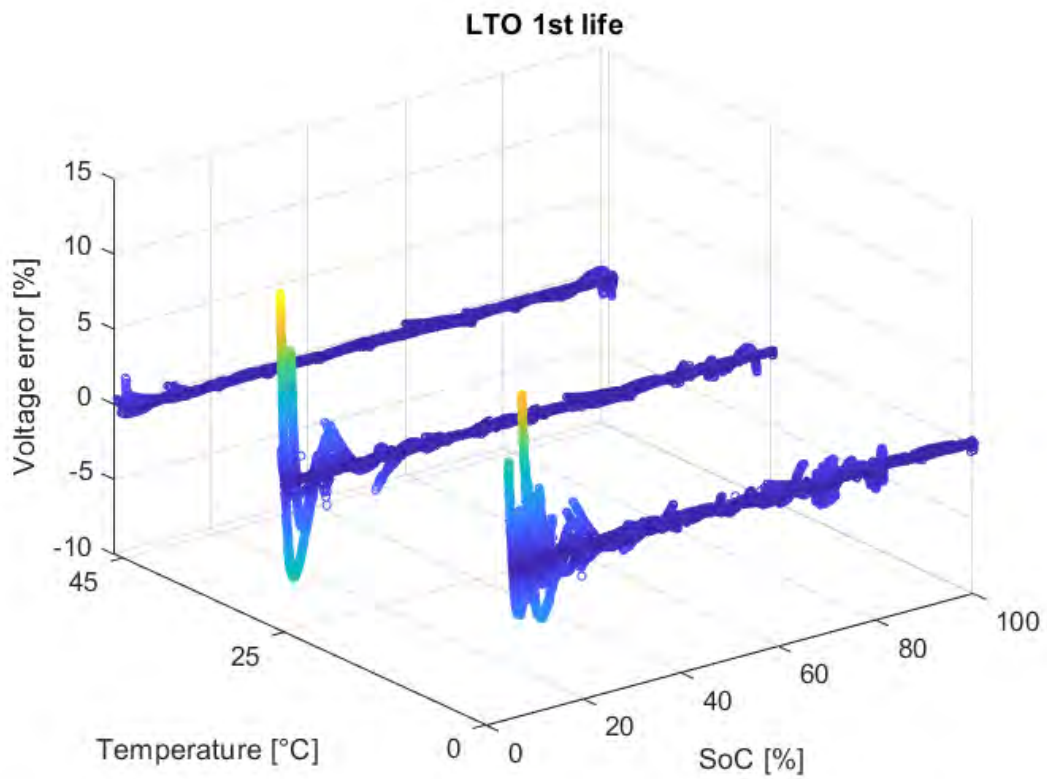

Figure 12: LTO 1st life cell model parameters identification error. Voltage error vs temperature and SoC for all C-Rate.

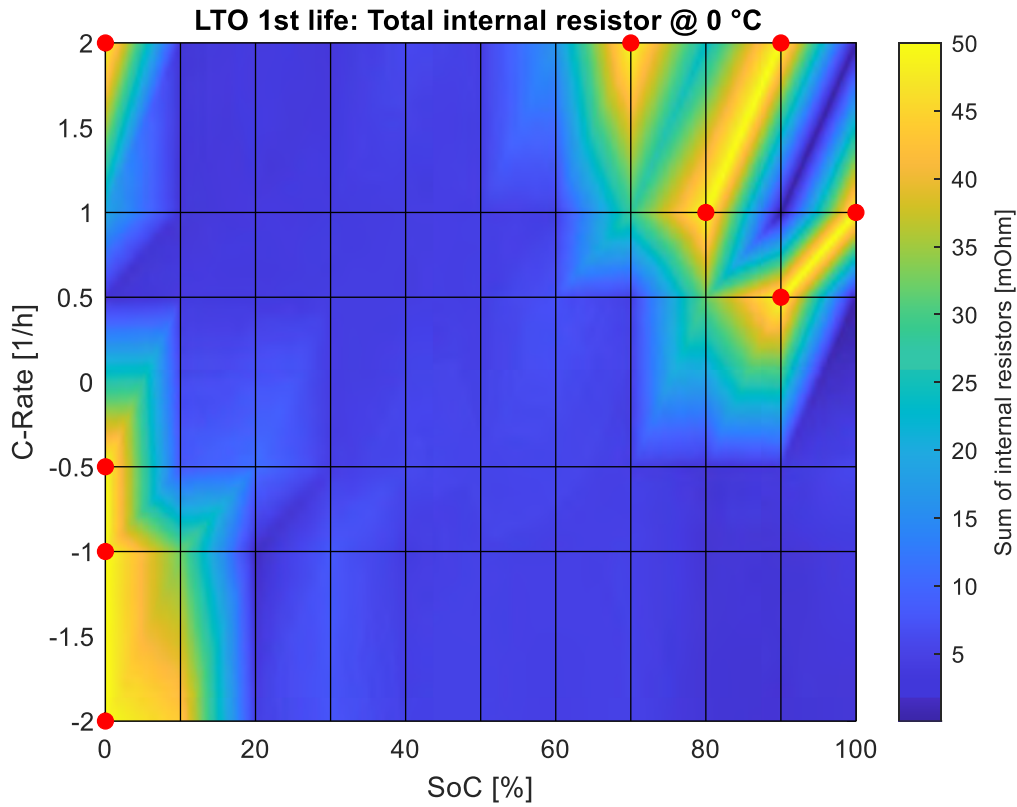

Figure 13: Sum of all internal resistance of LTO 1st life cell model at 0°C. Red markers show where values have been saturated.

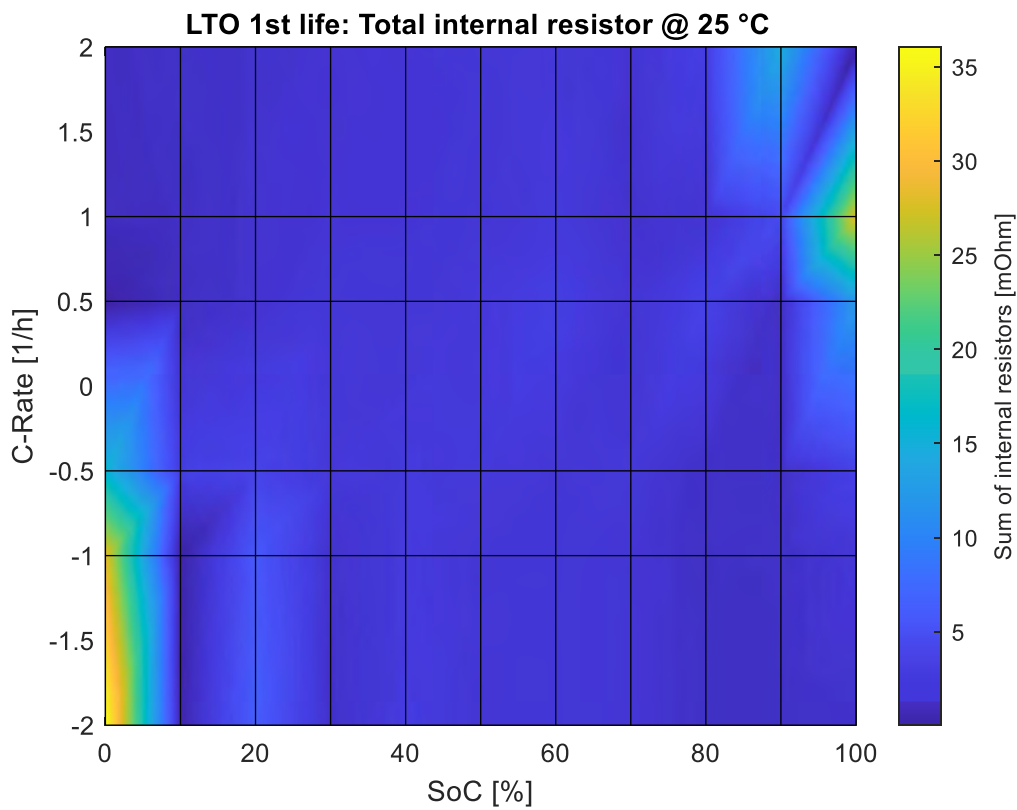

Figure 14: Sum of all internal resistance of LTO 1st life cell model at 25°C.

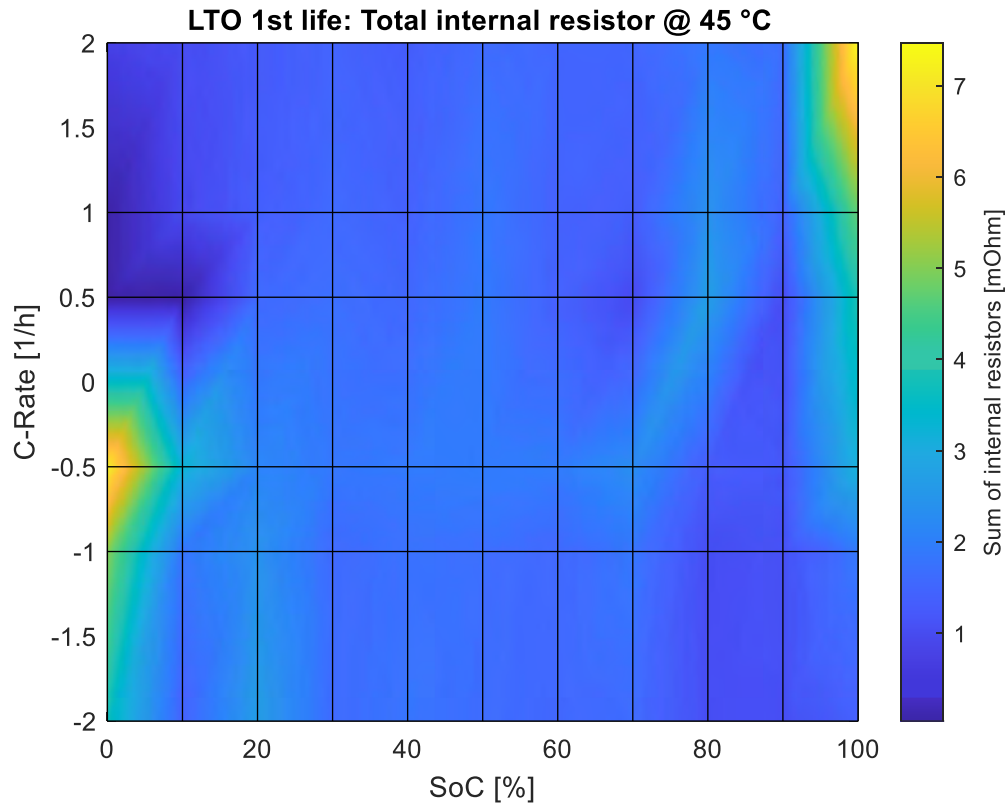

Figure 15: Sum of all internal resistance of LTO 1st life cell model at 45°C.

### 3.1.3 LFP 1<sup>st</sup> life cell

For LFP 1<sup>st</sup> life cell, low SoC lead also to higher uncertainty (figure 17 and figure 18). Total internal resistor has high and then saturated values for low temperature. For other points data have been saturated to low values ( $1e-5$ ) (figure 19, figure 20 and figure 21) in order to avoid negative values (not shown in graph). These negative values happened when HPPC pulse data does not fit the OCV data, especially at the beginning of the current pulse.

Identification of LFP 1<sup>st</sup> life cell model parameters will be improved at a later stage of the iSTORMY project, so that the simulation of the HESS remains accurate enough.

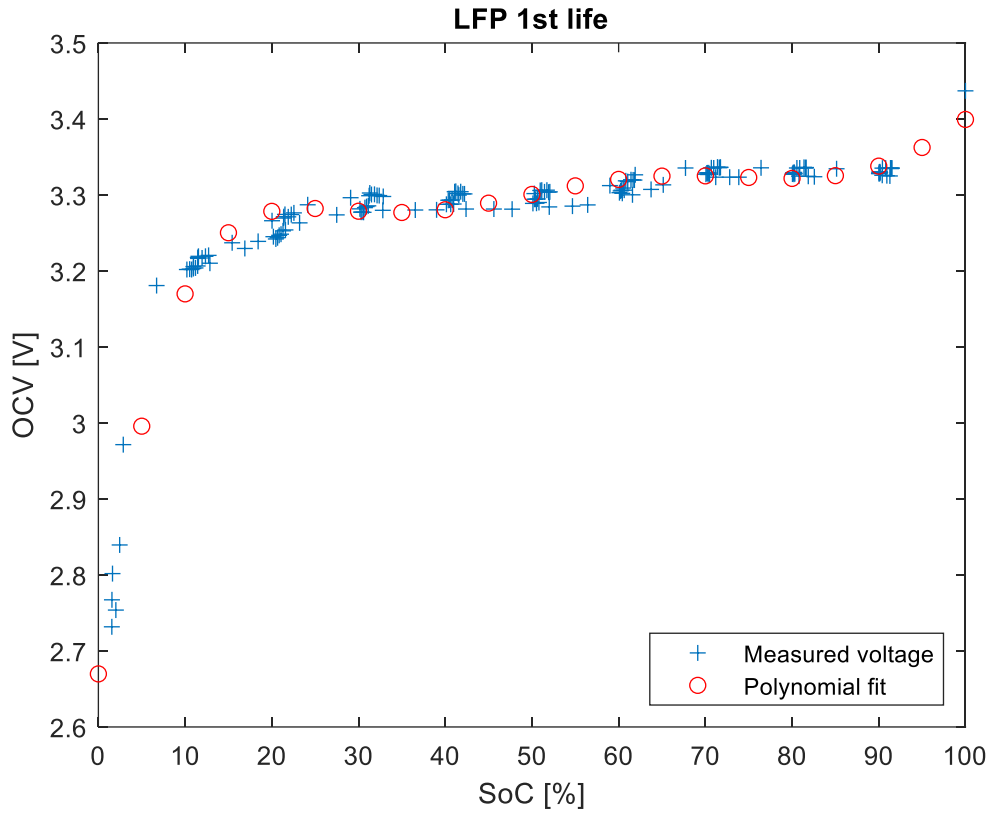

Figure 16: OCV identification for LFP 1<sup>st</sup> life cell.

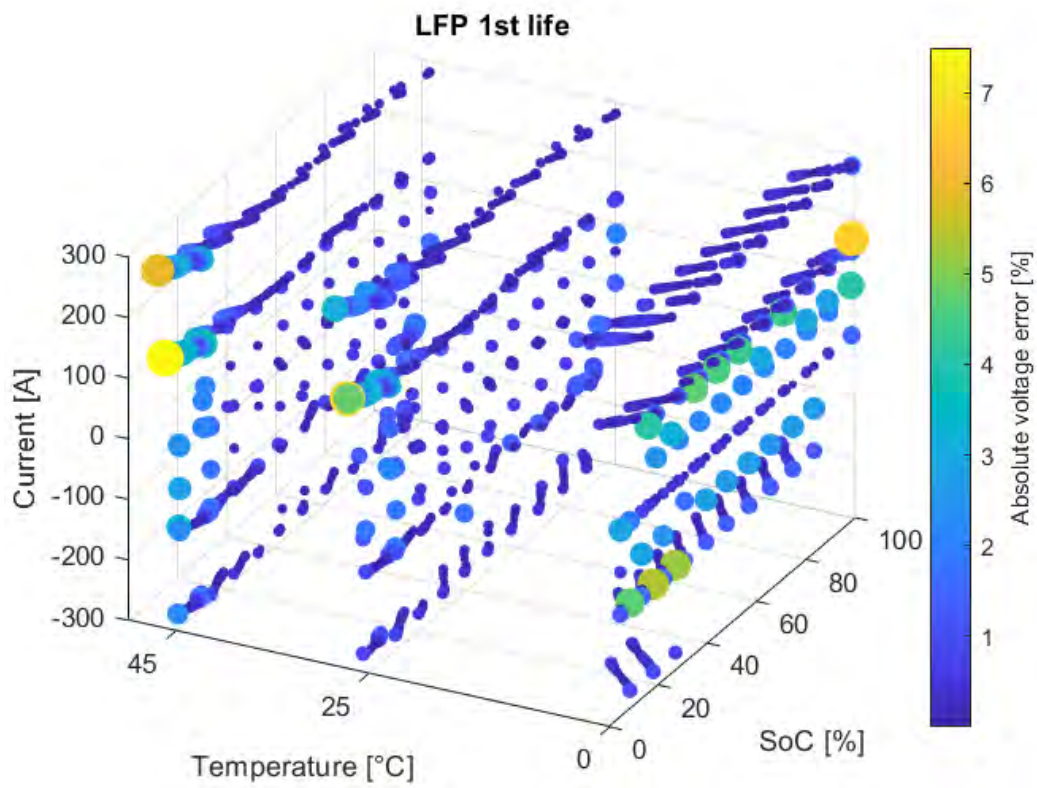

Figure 17: LFP 1<sup>st</sup> life cell model parameters identification error. Voltage error vs temperature, SoC and current.

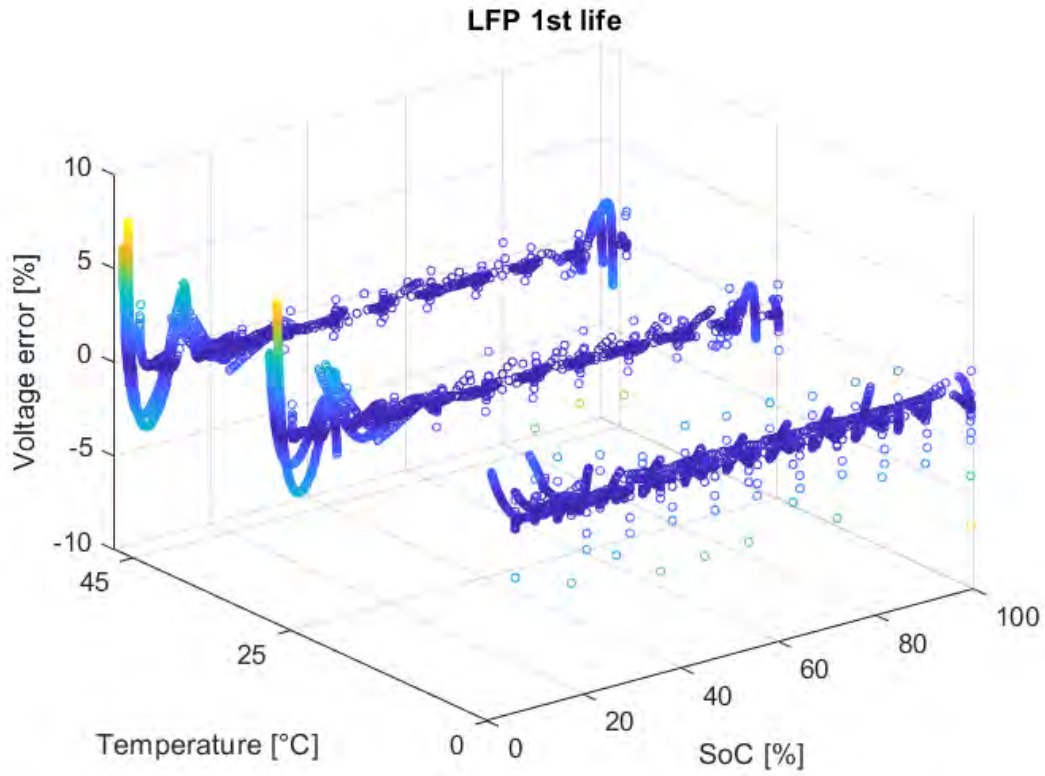

Figure 18: LFP 1<sup>st</sup> life cell model parameters identification error. Voltage error vs temperature and SoC for all C-Rate.

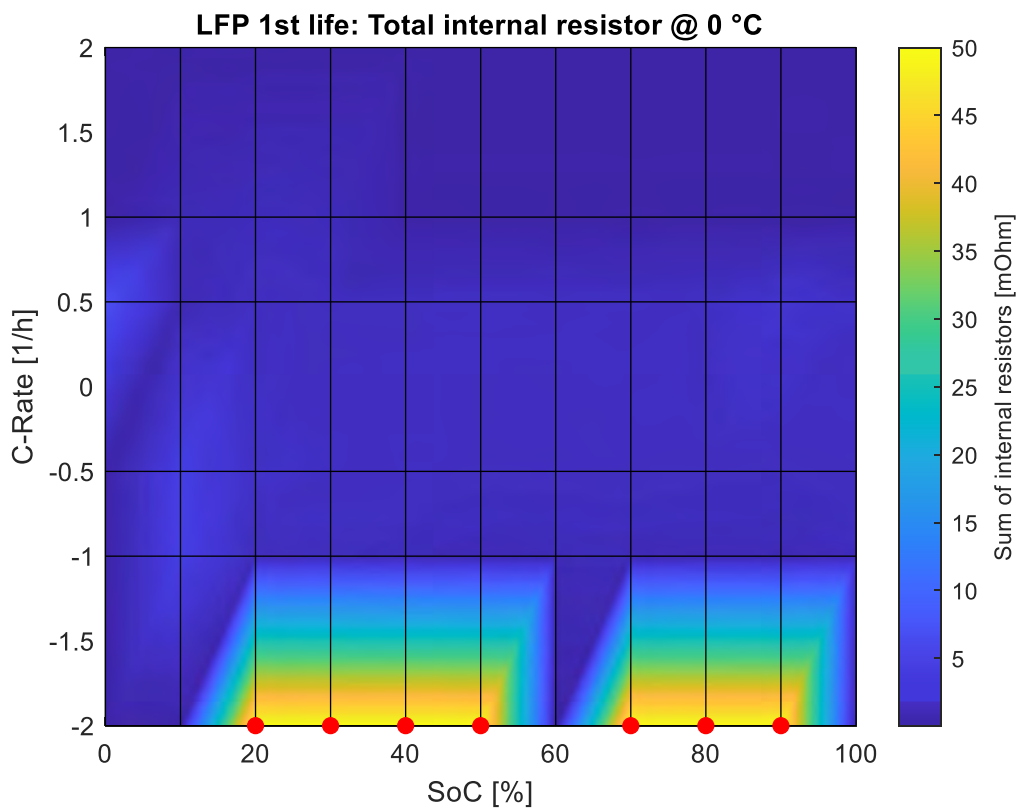

Figure 19: Sum of all internal resistance of LFP 1<sup>st</sup> life cell model at 0°C. Red markers show where values have been saturated.

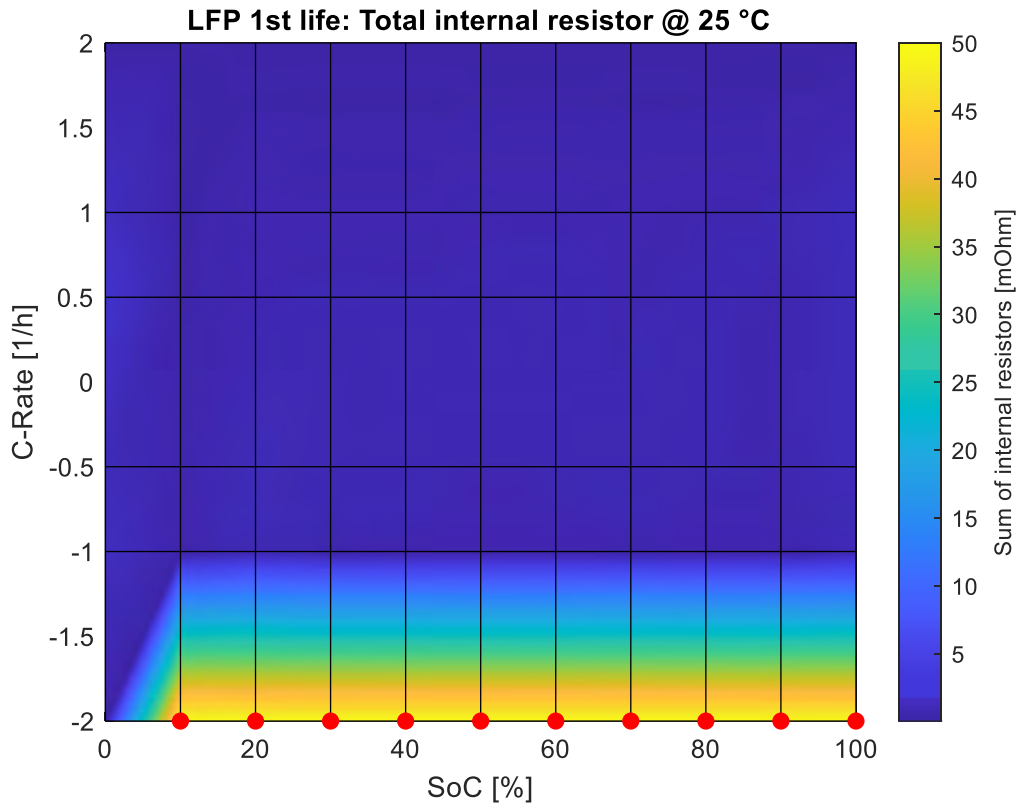

Figure 20: Sum of all internal resistance of LFP 1<sup>st</sup> life cell model at 25°C. Red markers show where values have been saturated.

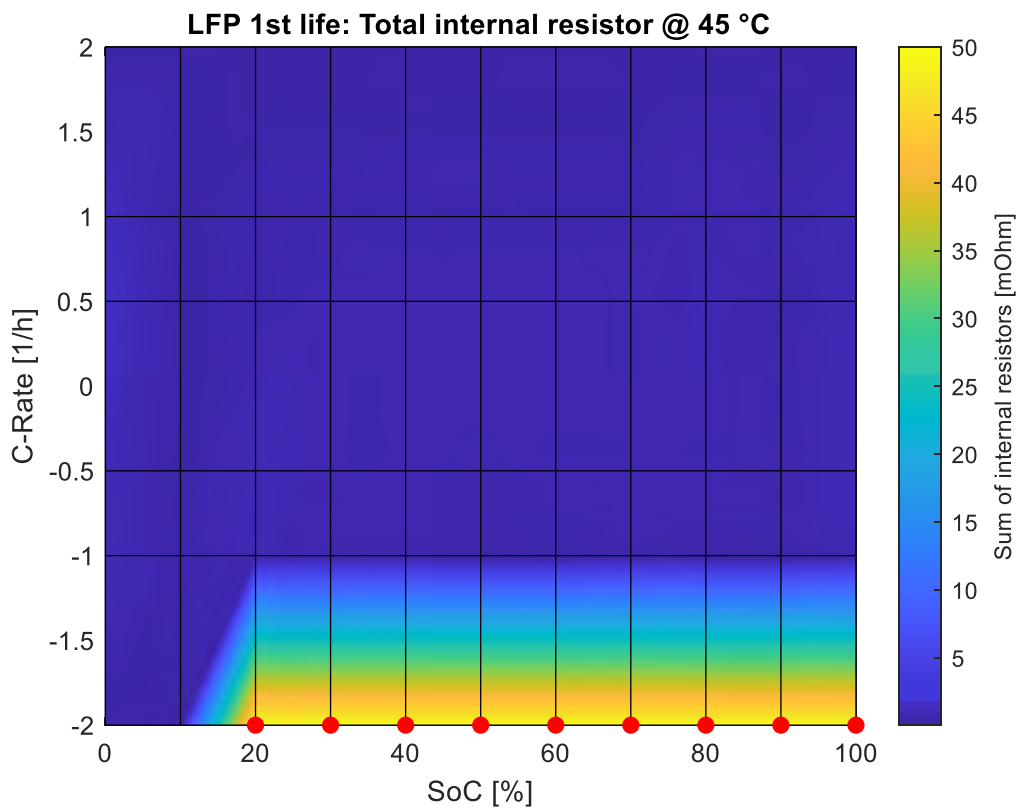

Figure 21: Sum of all internal resistance of LFP 1<sup>st</sup> life cell model at 45°C. Red markers show where values have been saturated.

### 3.1.4 LFP 2<sup>nd</sup> life cell

Discrepancies in cell test data have limited the identification process for LFP 2<sup>nd</sup> life cell. Thus, SoC calculation and OCV identification issues have been encountered. Therefore, LFP 2<sup>nd</sup> life cell model has been fitted for a limited number of values for currents, temperatures and SoC. The identification will be improved at a later stage of the iSTORMY project, so that the simulation of the HESS remains accurate enough. Current results show however a low uncertainty unless for low SoC at 25°C.

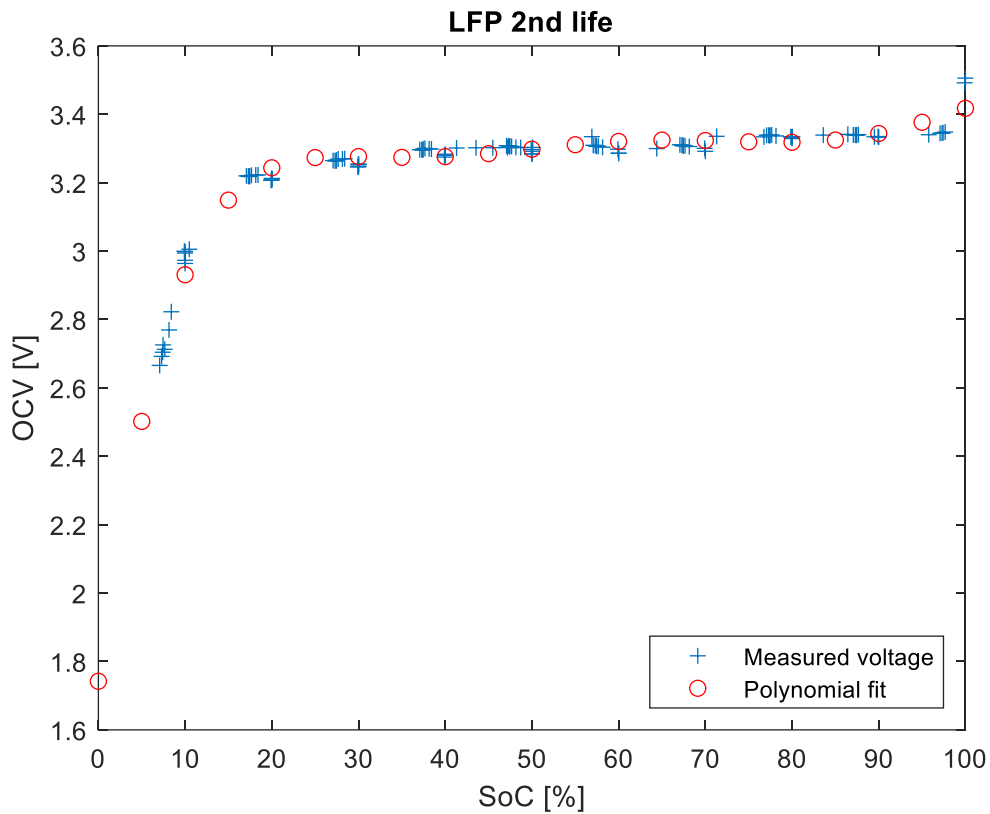

Figure 22: OCV identification for LFP 2<sup>nd</sup> life cells.



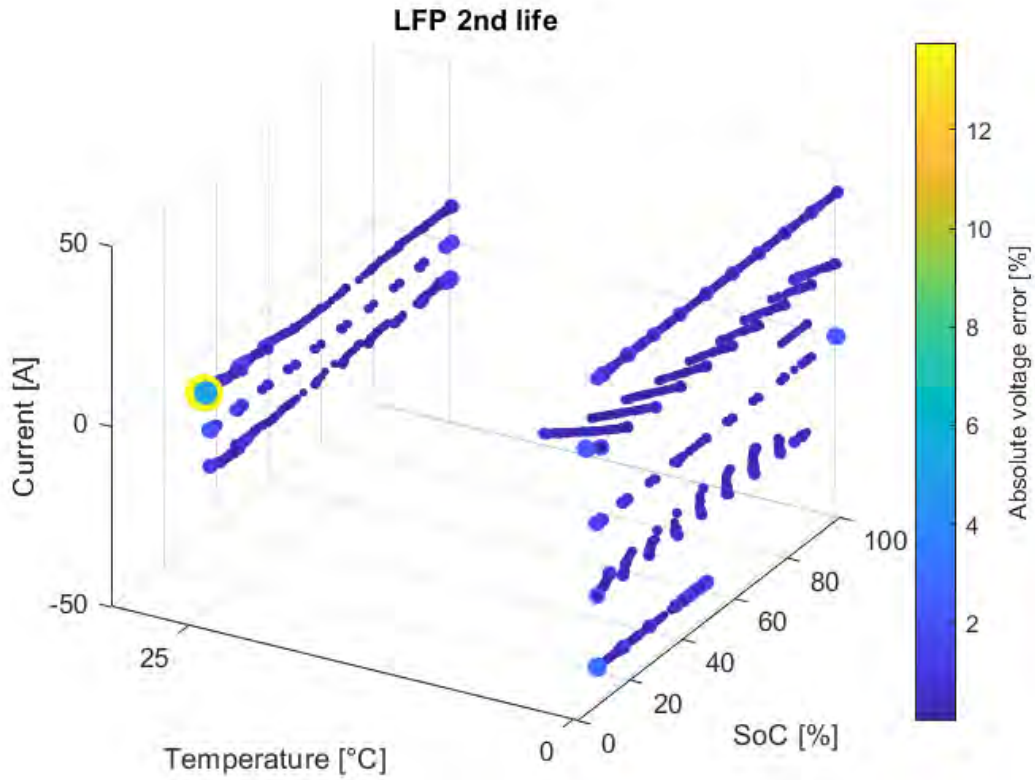

Figure 23: LFP 2<sup>nd</sup> life cell model parameters identification error. Voltage error vs temperature, SoC and current.

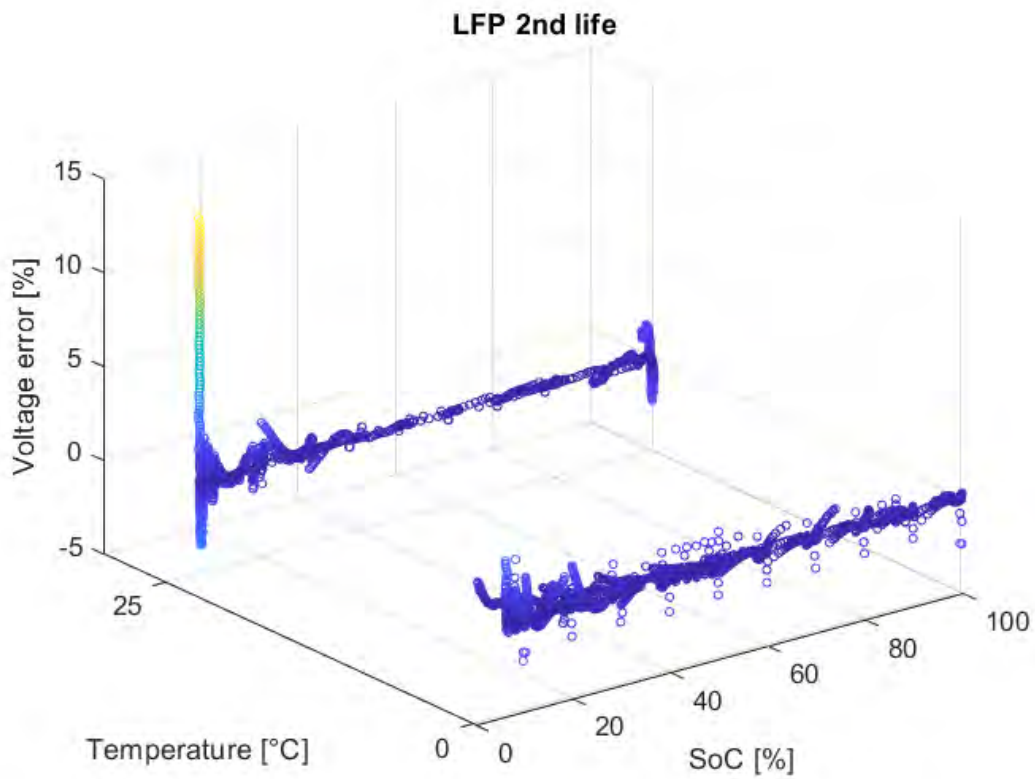

Figure 24: LFP 2<sup>nd</sup> life cell model parameters identification error. Voltage error vs temperature and SoC for all C-Rate.

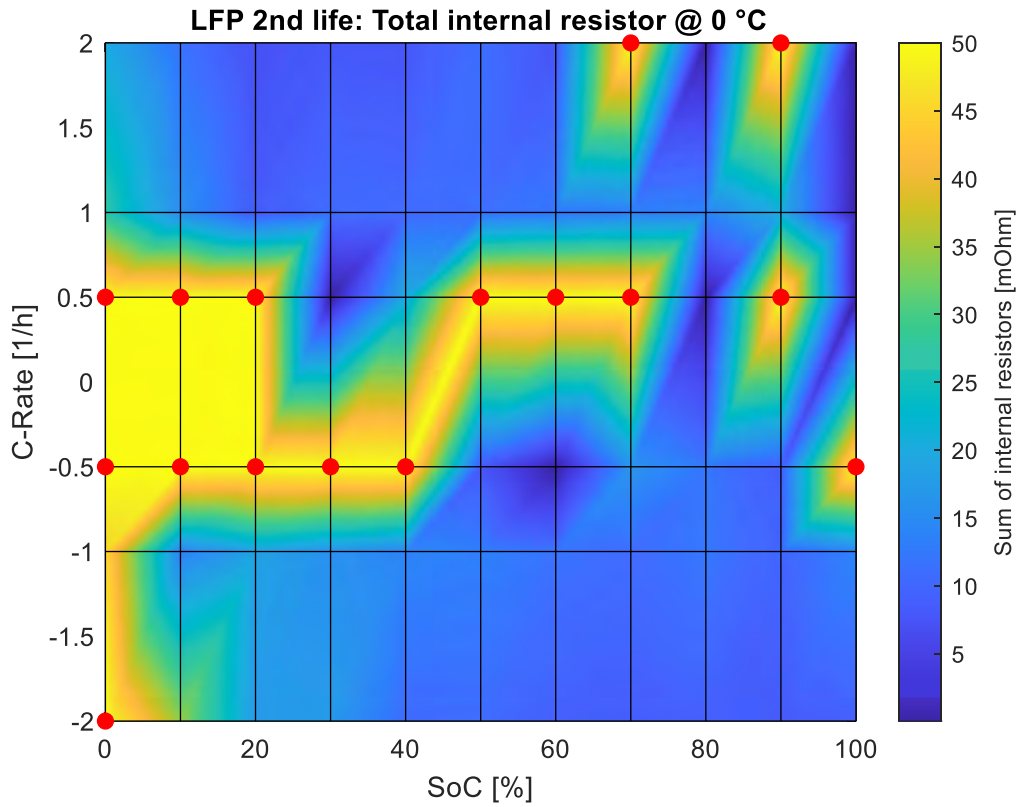

Figure 25: Sum of all internal resistance of 2<sup>nd</sup> life cell model at 0°C. Red markers show where values have been saturated.

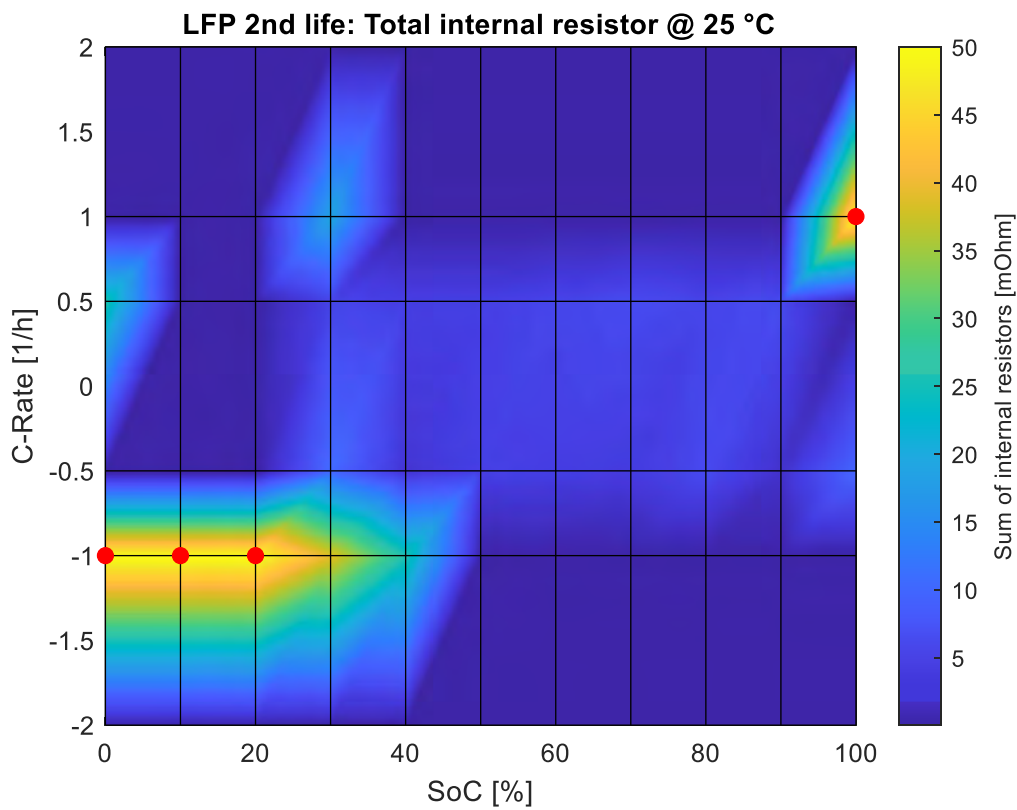

Figure 26: Sum of all internal resistance of LFP 2<sup>nd</sup> life cell model at 25°C. Red markers show where values have been saturated.

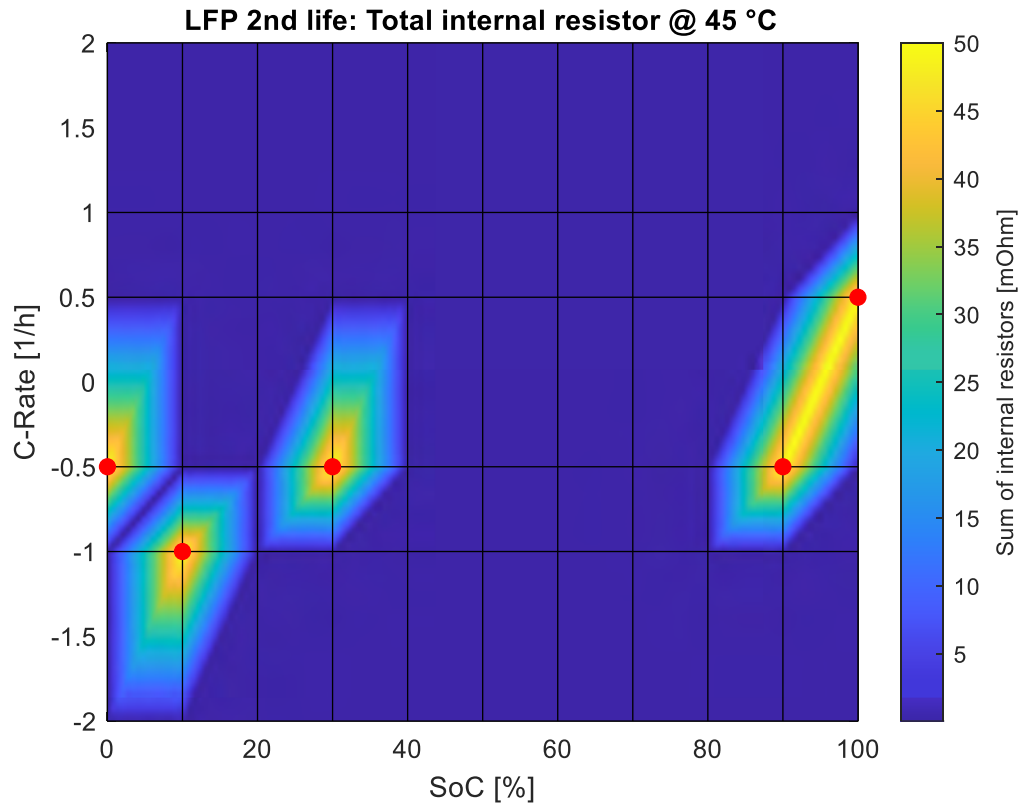

Figure 27: Sum of all internal resistance of LFP 2nd life cell model at 45°C. Red markers show where values have been saturated.

### 3.2 Discussion and conclusion

The results show that voltage error is below 2% for most simulated experimental points. Maximum errors (above 10%) are mostly obtained for low SoC values. The main reason is the difficulty to identify correctly OCV at low SoC values. Another reason is the relatively high inaccuracy of SoC computation during tests: a SoC calibration should preferably be performed between each HPPC phase.

However, considering the use cases configurations, we can assume<sup>3</sup> that the HESS is likely to be operated most of its time in a range of SoC above 10% to 20% and below 80% to 90%. Therefore, we can expect that, in this SoC range, the model remains accurate enough for optimization considerations. That is to say, the model is accurate enough for comparison studies (aging optimization, pre-sizing studies) but assumedly not for absolute sizing studies.

Therefore, we can conclude that the proposed model meets the objective of developing a “medium-fidelity model” set at the beginning of the task, i.e. with an accuracy objective of 5% or better.

In any case, in the short term, the parameters identification will be improved, especially at low SoC for both LFP references. In addition, LFP 1<sup>st</sup> and 2<sup>nd</sup> life test data will be properly processed and their identification improved for every value of SoC, temperature and current used during the test campaign.

<sup>3</sup> As we will optimized the aging of the HESS.

## 4 Risk Register

Risk No.	What is the risk	Probability of risk occurrence <sup>1</sup>	Effect of risk <sup>1</sup>	Solutions to overcome the risk
<b>WP2</b>	Accuracy of battery model is not high enough	2	1	Improve identification algorithm. Improve battery test campaign.
<b>WP2</b>	Accuracy of identification for LFP 1 <sup>st</sup> and 2 <sup>nd</sup> life cell is not accurate enough	1	1	Run a second identification with improved data processing. Already planned.

<sup>1</sup>) Probability risk will occur: 1 = high, 2 = medium, 3 = Low

## 5 References

- [1] « GRANT AGREEMENT 963527 — iSTORMY ». nov. 05, 2020.
- [2] G. L. Plett, *Battery management systems: battery modeling. Volume 1*. Boston : London: Artech House, 2015.
- [3] Guangming Liu *et al.*, « A comparative study of equivalent circuit models and enhanced equivalent circuit models of lithium-ion batteries with different model structures », in *2014 IEEE Conference and Expo Transportation Electrification Asia-Pacific (ITEC Asia-Pacific)*, Beijing, China, août 2014, p. 1-6. doi: 10.1109/ITEC-AP.2014.6940946.
- [4] J. V. Barreras *et al.*, « An improved parametrization method for Li-ion linear static Equivalent Circuit battery Models based on direct current resistance measurement », in *2015 International Conference on Sustainable Mobility Applications, Renewables and Technology (SMART)*, Kuwait, Kuwait, nov. 2015, p. 1-9. doi: 10.1109/SMART.2015.7399223.
- [5] J. Kowal, J. B. Gerschler, C. Schaper, T. Schoenen, et D. U. Sauer, « Efficient battery models for the design of EV drive trains », in *Proceedings of 14th International Power Electronics and Motion Control Conference EPE-PEMC 2010*, Ohrid, Macedonia, sept. 2010, p. 5606677. doi: 10.1109/EPEPEMC.2010.5606677.
- [6] A. Farmann et D. U. Sauer, « A study on the dependency of the open-circuit voltage on temperature and actual aging state of lithium-ion batteries », *J. Power Sources*, vol. 347, p. 1-13, avr. 2017, doi: 10.1016/j.jpowsour.2017.01.098.

## Acknowledgement

The author(s) would like to thank the partners in the project for their valuable comments on previous drafts and for performing the review.

### Project partners:

#	Partner short name	Partner Full Name
1	VUB	VRIJE UNIVERSITEIT BRUSSEL
2	PWD	POWERDALE
3	CEG	CEGASA ENERGIA S.L.U.
4	CEA	COMMISSARIAT A L ENERGIE ATOMIQUE ET AUX ENERGIES ALTERNATIVES
5	MGEP	MONDRAGON GOI ESKOLA POLITEKNIKOA JOSE MARIA ARIZMENDIARRIETA S COOP
6	ZIG	ZIGOR RESEARCH & DEVELOPMENT AIE
7	EDF	ELECTRICITE DE FRANCE
8	TNO	NEDERLANDSE ORGANISATIE VOOR TOEGEPAST NATUURWETENSCHAPPELIJK ONDERZOEK TNO
9	PT	PRODRIVE TECHNOLOGIES BV
10	GW	GREENWAY INFRASTRUCTURE SRO
11	AIT	AIT AUSTRIAN INSTITUTE OF TECHNOLOGY GMBH
12	UNR	UNIRESEARCH BV



*This project has received funding from the European Union's Horizon 2020 research and innovation programme under grant agreement No 963527*

## Appendix A – Use cases configuration

The use cases configurations are described in Deliverable 1.1 and summarized in the table below:

Use case requirement					
item	network configuration	Regulatory framework	criteria	value	KPI
Use case 1 :Pan european grid - frequency support	connected to the main grid	UK 2015 Enhanced frequency response requirement (TSO national grid)	Time response when deviation over 500 mHz	1s	Time response when strong deviation
			Time delivery when deviation over 500 mHz	30 minutes	Time delivery
			Power tolerance	5% of the subscribed power	% of time operating the service
			time over the year operating the support	No criteria	SoX
Use case 2 : Pan european grid - EV charging station integration Grid services :		Puerto rico island for the ramp  Technical requirement at the substation level  European market	Maximum Ramp rate	10% of the rated power/minute = 10 kW/min	Average ramp rate at the coupling point (1 minute measurement)
			Maximum peak consumption	Power subscribed in the contract (100 kVA)	Maximum peak power and % of time exceeding the limit
			Billing management based on intra day price	/	financial earning
Use case 3 : microgrid - frequency support & daily energy shifting		French island grid code (EDF SEI operator)  Financial requirement	No Frequency deviation upper limit 1	2 Hz	Average frequency deviation
			No Frequency deviation upper limit 2	3 Hz	%Time over the limit 1 and 2
			Optimize PV shifting	0 PV curtailment	% of PV production curtailed